

<b>Order code</b>	<b>Manufacturer code</b>	<b>Description</b>
18-1126	n/a	12V 33AH GEL BATTERY EV RANGE HAZE (RE)

	Page 1 of 17
The enclosed information is believed to be correct, Information may change without notice due to product improvement. Users should ensure that the product is suitable for their use. E. & O. E.	Revision A 20/02/2007



Haze Battery Company Ltd



**Sealed Lead Acid 6 & 12 Volt  
Monobloc  
Gelled Electrolyte Range**

**CONSTRUCTION** - Gel battery construction is as shown in the diagram. The positive and negative grids are cast from a calcium/tin lead alloy to reduce grid growth and corrosion. The active material is manufactured from a high purity lead (99.9999%) to minimize the negative effects of impurities.

Separator is manufactured by a world leader in the field, utilizing the latest German technology. The base material is a microporous duroplastic exhibiting excellent high temperature stability and mechanical strength, resulting in very good resistance to vibration and mechanical shock. The integrity of the battery will be maintained under extreme conditions.

The purpose of the separator is to maintain a constant distance between the positive and negative plates, totally eliminating the possibility of short circuits whilst allowing the active materials to fully react with the gelled electrolyte.

The separator also has an open construction, which allows little resistance to the flow of the electrolyte during filling.

A thin layer (typically 0.4mm) of non-woven glass mat is an integral part of the separator and is placed against the positive plate for improved surface contact.

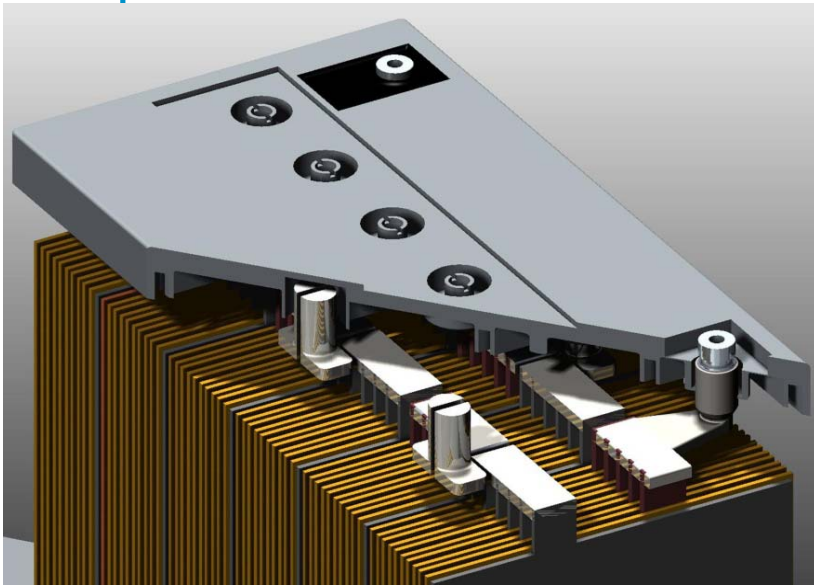

Typical separator properties are:

Acid displacement -150 ml/sqm

Pore volume - 70%

Average pore size - 0.5 micro m

Maximum pore Diameter - 1 micro m

Gel construction with case removed and cover cut away to show internal battery parts.

**ELECTROLYTE FILLING** - Gelled electrolyte is introduced to the cell by means of custom-built vacuum filling machines. It is vitally important that the electrolyte achieves full penetration of the separator and plates therefore; vacuum cycling is utilized after the filling process. To ensure each cell has the correct amount of gel, they are first overfilled, the extra gel is then removed. The battery design and construction negates the need for electrolyte addition and the battery remains maintenance free throughout its design life.



**SAFETY RELEASE VALVE**- The battery will operate above atmospheric pressure under normal operating conditions, however the maximum pressure is governed by the safety release valve. Open is activated by pressures in excess of approx. 2 psi (14 Kpa), resealing at approx 1.2 psi (8.4 Kpa).

**GAS RECOMBINATION** - The gasses generated during normal operation of the battery are internally recombined. In fact more than 99% of the gas achieves recombination.

**TERMINAL CONSTRUCTION** - The contact quality between the insert terminal and the lead post is of vital importance during short duration / high Amp discharges. Elevated terminal temperatures are the result of poor contact, eventually causing seal degradation and electrolyte leaks. Haze design and assembly technique for terminal casting ensures trouble free operation for the design life of the battery.

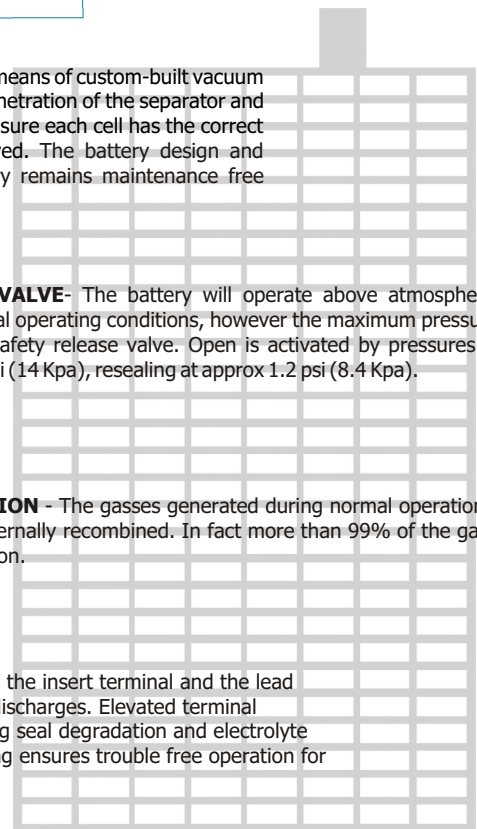

## Gel Vs AGM

Each battery has its advantages and disadvantages, it is therefore important to choose the right battery for the application. Advantages of Gel Batteries:

- Full recovery from deep discharge, even when the battery is not recharged immediately.
- Ideal for repeat cycling daily use.
- Excellent performance over long discharges
- Good tolerance to higher temperature applications
- Suitable where mains power is unstable
- Zero stratification due to immobilized electrolyte
- No equalization charge necessary
- Reduced self-discharge
- Limiting design protects the positive plates to greatly improve cycle life
- Improved charge acceptance due to low internal resistance
- High resistance to water loss with the right charging set up
- Ultra stable polymer separator with glass mat for increased performance
- High resistance to shorting due to superior mechanical strength of the polymer separator
- Increased tolerance to poor charging parameters
- Can be discharged even when full recharge has not been achieved, without loss of battery capacity



## Applications

- Float service
  - Residential
  - Telecommunications
  - Refrigeration
  - Poor charging applications
  - Frequent use applications
  - Wind
  - Engine Starting
  - Higher ambient temperature applications
  - Water Pumping
  - Road side cabinets
  - Cathodic Protection
- Many other extreme applications

### Capacity temperature correction Factor to be applied to Data at 20 Degrees C

Discharge Time	-30 °C	-20 °C	-10 °C	0 °C	5 °C	10 °C	15 °C	20 °C	25 °C	30 °C	35 °C	40 °C	50 °C
5 minutes to 59 minutes	0.23	0.417	0.605	0.778	0.86	0.91	0.96	1	1.037	1.063	1.085	1.1	1.116
1 Hour to 100 Hours	0.277	0.464	0.647	0.816	0.886	0.93	0.97	1	1.028	1.05	1.063	1.07	1.078

**CHEMICAL REACTION-** The chemical reaction for the Discharge / Recharge process is represented by the following formula:



Under normal float charge conditions the oxygen passes through the separator from the positive to the negative plate where it reacts with the negative active material to form lead oxide.

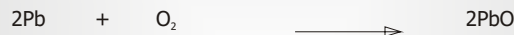

In the acid conditions the lead oxide reacts with the sulfuric acid to form lead sulphate.

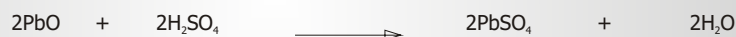

The lead sulphate formed on the negative is then reduced to lead and sulfuric acid by the evolving hydrogen.

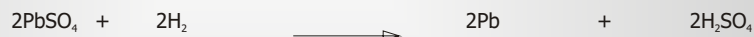

If the equations are resolved and like terms cancelled out on both sides of the equation the result is:

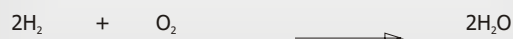

This reaction summarises what is meant by GAS RECOMBINATION. The process can never be 100% efficient, normal recombination efficiency is 95 - 99%.

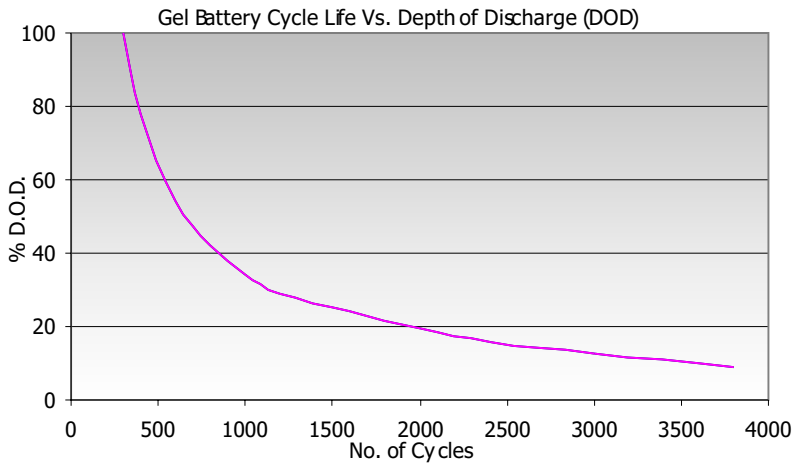

### Innovative Features

- Completely maintenance free, sealed
- Construction eliminates the need for watering
- Electrolyte will not stratify, no equalization charge required
- Increased durability and deep cycle ability for heavy demand applications
- Special formation process
- Gelled thixotropic electrolyte
- Spill proof / leak proof
- Valve regulated Max internal pressure 2.5 psi
- Multi-position usage
- Multi-cell container
- ABS Case and cover - VO on request
- Low self discharge
- Utilising the latest in European technology
- FAA and IATA approved as non-hazardous

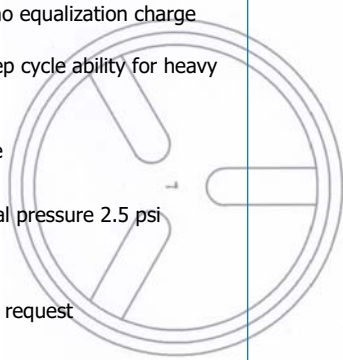

### Specifications

Nominal Voltage	6 & 12 Volts
Design Life	12 Years
Operating Temperature	-20 °C to 50 °C
Grid alloy	Calcium / Tin lead alloy
Plates	Flat Pasted
Separator	Microporous Duroplastic
Active material	Very high purity lead
Case and cover	ABS (VO on request)
Charge Voltage	Float 2.27 - 2.30 VPC @20 °C Cycling 2.4 @20 °C
	Max. 2.4 VPC Max ripple 3.5% Charge V
Electrolyte	Sulphuric acid Analytical grade purity
Venting Valve	EPDM Rubber 1.5 to 2 psi (10.5 - 14 KPa) release pressure. Resealing at 1 psi (7 KPa)
Terminal	Various types Epoxy sealed by extended mechanical paths
Torque setting	The recommended torque value for all types is 5-7 Nm
Cables	Insulated cables / connectors supplied on request.

Haze Battery Company keenly encourages environmental awareness; PLEASE follow guidelines for the recycling /disposal of lead.

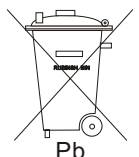
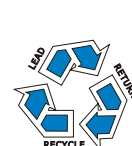
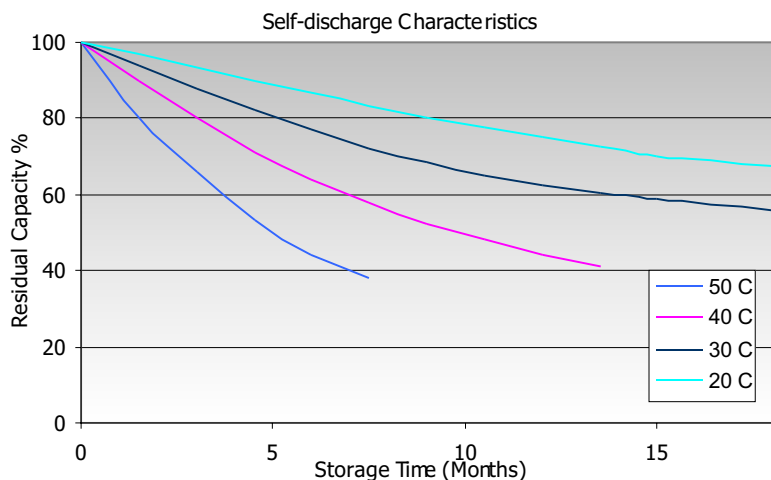

Relationship Between Charge Voltage and Temperature

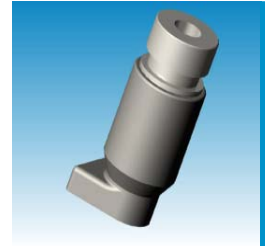
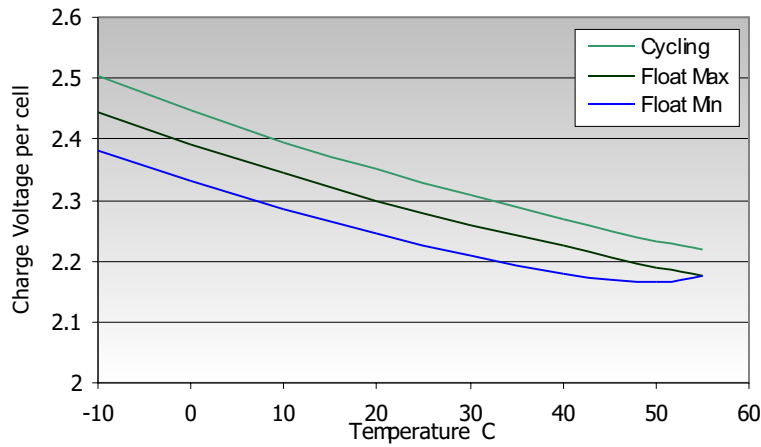

Capacity Vs Ambient Temperature

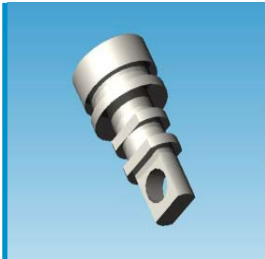
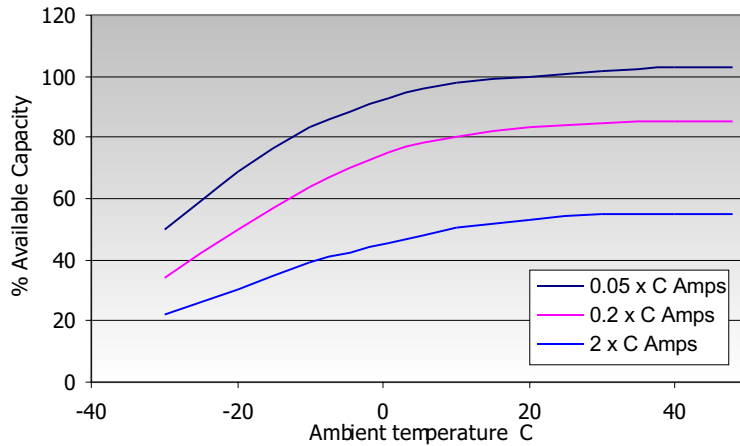

**CHARGING CHARACTERISTICS**

**Floating** - The optimum float voltage for a battery is temperature dependant, at 15 - 24°C the recommended value is 2.27 - 2.30V. It is recommended that battery installation sites are temperature controlled, however float voltage can be increased or decreased to compensate for temperature variations. Adjustment is calculated at +/- 3 mV per degree C.

**Terminal Options** (left to right)

- ▶ Lead Flag
- ▶ Automotive
- ▶ J Type
- ▶ Copper Flag
- ▶ J Type Adapter
- ▶ Insert

Insert are made from brass with copper, nickel and silver plating giving excellent mechanical, electrical and corrosion resistant properties.

Operating Temperature	Recommended Applied Float Voltage VPC
0-9	2.33 - 2.35
10-14	2.30 - 2.33
15-19	2.27 - 2.30
20-24	2.27 - 2.30
25-29	2.25 - 2.27
30-34	2.23 - 2.25
35-40	2.21 - 2.23

The most suitable charging method for battery life and performance is the constant voltage method with a limited initial current, usually limited to a maximum of  $C_{20}/4$ .

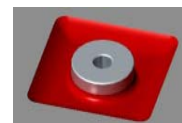
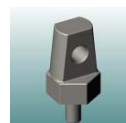
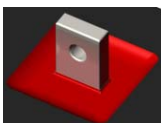



Battery Model	Time in Hours Ah to 1.75 VPC									
	2	3	4	5	6	7.05	8	10	12	20
HZY6-7.5	4.8	5.15	5.4	5.58	5.73	5.86	5.98	6.23	6.46	7.33
HZY6-10	6.85	7.3	7.58	7.82	8.03	8.21	8.38	8.70	8.97	9.99
HZY6-12	8.02	8.62	8.98	9.29	9.57	9.83	10.0	10.43	10.8	11.93
HZY12-7.5	4.8	5.15	5.40	5.58	5.73	5.86	5.98	6.23	6.46	7.33
HZY12-12	8.02	8.62	8.98	9.29	9.57	9.83	10.0	10.43	10.8	11.93
HZY12-18	10.78	11.6	12.12	12.5	12.8	13.07	13.29	13.75	14.22	15.48
HZY12-26	17.89	19.42	20.42	21.06	21.5	21.89	22.17	22.77	23.27	25.49
HZY12-33	20.82	21.97	23.04	23.92	24.75	25.48	26.21	27.4	28.41	31.65
HZY12-44	27.81	29.12	30.24	31.07	31.9	32.73	33.42	34.66	35.63	39.0
HZY12-55	34.91	37	38.74	39.95	41.07	42.1	42.94	44.53	45.65	50.42
HZY12-60	35.01	38.52	41.56	44.2	46.6	48.5	50.08	53.0	54.75	57.32
HZY12-70	45.5	47.2	48.6	49.8	50.9	51.9	52.8	54.7	56.3	61.7
HZY12-70	46	47.87	49.44	50.9	52.2	53.6	54.6	56.8	58.9	64.7
HZY12-80	53.4	55.7	57.7	59.4	61.1	62.6	63.7	66.1	68.2	75.0
HZY12-90	60.0	63	65.1	66.7	68.2	69.4	70.4	72.8	75.0	82.7
HZY12-100	61.9	65.3	67.9	70.1	72.3	74.1	75.8	78.7	81.0	89
HZY12-110	70.4	73.8	76.7	79.3	81.9	84.0	85.9	89.3	92.4	102.9
HZY12-115	77.5	84.1	88.6	91.7	95.3	98.1	100.6	105	108	115
HZY12-120	78.5	83.3	86.3	89.0	91.7	93.9	95.9	99.7	102.6	111.8
HZY12-135	93.63	100.5	105.2	108.7	111.9	114	115.5	119.7	123.2	135
HZY12-150	99.1	103.3	106.8	110	113	116.1	118.4	123.1	127.5	142.2
HZY12-160	113	118	123	127	130	134	136	141	144	154
HZY12-200	133	140	146	150	154	158	161	168	173	191
HZY12-230	149	158	165	171	176	181	185	192	199	220
HZY12-230	149	158	165	171	176	181	185	192	199	220
HZY6-110	72.2	76.2	79.1	81.6	84.1	86.6	88.7	92.5	95.6	106.5
HZY6-155	121	130	137	142	148	153	157	165	172	187.9
HZY6-160	118	124	129	133	137	141	144	149	154	171
HZY6-200	133	141	147	152	156	160	163	170	175	191

Battery Model	Time in Hours Ah to 1.70 VPC									
	2	3	4	5	6	7	8	10	12	20
HZY6-7.5	4.89	5.24	5.47	5.66	5.81	5.96	6.08	6.33	6.57	7.49
HZY6-10	6.94	7.4	7.69	7.92	8.14	8.33	8.50	8.83	9.133	10.23
HZY6-12	8.12	8.71	9.09	9.41	9.7	9.96	10.19	10.63	11.0	12.24
HZY12-7.5	4.89	5.24	5.47	5.66	5.81	5.96	6.08	6.33	6.57	7.49
HZY12-12	8.12	8.71	9.09	9.41	9.7	9.96	10.19	10.63	11.0	12.24
HZY12-18	10.92	11.76	12.28	12.69	13.0	13.26	13.51	14.0	14.46	16.24
HZY12-26	18.12	19.74	20.7	21.34	21.82	22.21	22.55	23.17	23.81	26.09
HZY12-33	21.09	22.32	23.43	24.39	25.17	25.9	26.63	27.83	28.88	32.38
HZY12-44	28.15	29.51	30.65	31.59	32.44	33.22	34.0	35.18	36.28	39.71
HZY12-55	35.43	37.76	39.46	40.7	41.94	42.94	43.79	45.47	46.87	51.93
HZY12-60	35.5	39.01	42.14	44.8	47.4	49.7	50.77	53.8	55.44	58.01
HZY12-70	46	47.7	49.3	50.5	51.6	52.6	53.6	55.5	57.3	63.07
HZY12-80	54	56.5	58.5	60.3	62.1	63.6	64.9	67.5	69.8	77.4
HZY12-90	61.0	64.2	66.3	67.9	69.4	70.6	71.91	74.49	76.7	84.52
HZY12-100	62.7	66.29	69.7	71.16	73.31	75.3	77.1	80.1	82.8	91.4
HZY12-110	71.3	74.9	77.9	80.5	83.1	85.1	87.2	90.7	94.5	105.7
HZY12-115	78.5	84.7	89.2	92.6	95.8	99.0	101	106	109	116
HZY12-120	79.5	84.7	87.8	90.5	93.2	95.7	98.3	102	105.1	114.7
HZY12-135	94.76	101.8	106.7	110.1	113.3	115.5	117.2	121.4	125.3	137.6
HZY12-150	100.5	105.2	108.9	112.2	115.6	118.4	121.3	126.5	130.9	146.9
HZY12-160	114	120	125	129	132	135	138	143	146	157
HZY12-200	134	142	148	153	157	160	164	171	177	196
HZY12-230	151	160	167	173	178	183	188	196	202	225
HZY6-110	73.5	77.61	80.51	83.3	86.09	88.88	90.4	94.3	97.9	109.2
HZY6-155	122	132	139	145	151	156	160	168	175	192
HZY6-160	119	125	131	135	139	144	146	152	157	174
HZY6-200	135	143	150	155	159	163	167	174	179	197

Battery Model	Amps to 1.75 VPC									
	2	3	4	5	6	7	8	10	12	20
HZY6-7.5	2.40	1.72	1.35	1.12	0.96	0.84	0.75	0.62	0.54	0.37
HZY6-10	3.43	2.43	1.90	1.56	1.34	1.17	1.05	0.87	0.75	0.50
HZY6-12	4.01	2.87	2.25	1.86	1.60	1.40	1.25	1.04	0.90	0.60
HZY12-7.5	2.40	1.72	1.35	1.12	0.96	0.84	0.75	0.62	0.54	0.37
HZY12-12	4.01	2.87	2.25	1.86	1.60	1.40	1.25	1.04	0.90	0.60
HZY12-18	5.39	3.87	3.03	2.51	2.13	1.87	1.66	1.38	1.19	0.79
HZY12-26	8.95	6.47	5.11	4.21	3.58	3.13	2.77	2.28	1.95	1.27
HZY12-33	10.4	7.32	5.76	4.78	4.13	3.64	3.28	2.74	2.37	1.58
HZY12-44	13.9	12.7	7.56	6.21	5.32	4.68	4.18	3.47	2.97	1.95
HZY12-55	17.5	9.23	9.7	7.99	6.85	6.01	5.37	4.45	3.80	2.52
HZY12-60	17.5	12.8	10.39	8.84	7.77	6.93	6.26	5.30	4.56	2.87
HZY12-70	22.8	15.7	12.2	10.0	8.88	7.94	7.16	6.00	5.47	3.09
HZY12-70	23.0	16.0	12.4	10.2	8.70	7.66	6.83	5.68	4.91	3.24
HZY12-80	26.7	18.6	14.4	11.9	10.2	8.94	7.96	6.61	5.68	3.75
HZY12-90	30.0	21.0	16.3	13.3	11.4	9.9	8.80	7.28	6.25	4.14
HZY12-100	31.0	21.8	17.0	14.0	12.1	10.6	9.48	7.87	6.75	4.45
HZY12-110	35.2	24.0	19.2	15.9	13.7	12.0	10.7	8.93	7.70	5.15
HZY12-115	38.8	28.0	22.2	18.3	15.9	14.0	12.6	10.50	8.98	5.74
HZY12-120	39.3	27.8	21.6	17.8	15.3	13.4	12.0	10.0	8.55	5.59
HZY12-135	46.8	33.5	26.3	21.7	18.7	16.3	14.4	12.0	10.26	6.75
HZY12-150	49.6	34.4	26.7	22.0	18.8	16.6	14.8	12.3	10.6	7.11
HZY12-160	56.3	39.5	30.8	25.4	21.7	19.1	17.0	14.1	12.0	7.68
HZY12-200	66.3	46.7	36.4	30.0	25.7	22.5	20.1	16.8	14.5	9.57
HZY12-230	74.7	52.6	41.1	34.1	29.3	25.9	23.2	19.2	16.5	11.0
HZY6-110	36.1	25.4	19.8	16.3	14.0	12.4	11.1	9.25	7.97	5.33
HZY6-155	63.1	43.5	34.3	28.5	24.6	21.9	19.7	16.53	14.33	9.39
HZY6-160	58.9	41.2	32.2	26.6	22.9	20.1	18.0	14.9	12.9	8.48
HZY6-200	66.3	47.1	36.8	30.3	26.0	22.9	20.4	17.0	14.6	9.57

Battery Model	Amps to 1.70 VPC									
	2	3	4	5	6	7	8	10	12	20
HZY6-7.5	2.45	1.75	1.37	1.13	0.97	0.85	0.76	0.63	0.55	0.37
HZY6-10	3.47	2.47	1.92	1.58	1.36	1.19	1.06	0.88	0.76	0.51
HZY6-12	4.06	2.90	2.27	1.88	1.62	1.42	1.27	1.06	0.92	0.61
HZY12-7.5	2.45	1.75	1.37	1.13	0.97	0.85	0.76	0.63	0.55	0.37
HZY12-12	4.06	2.90	2.27	1.88	1.62	1.42	1.27	1.06	0.92	0.61
HZY12-18	5.46	3.92	3.07	2.54	2.17	1.89	1.69	1.40	1.21	0.81
HZY12-26	9.06	6.58	5.18	4.27	3.64	3.17	2.82	2.32	1.98	1.30
HZY12-33	10.5	7.44	5.86	4.88	4.20	3.70	3.33	2.78	2.41	1.62
HZY12-44	14.1	9.8	7.66	6.32	5.41	4.75	4.25	3.52	3.02	1.99
HZY12-55	17.7	12.6	9.9	8.14	6.99	6.13	5.47	4.55	3.91	2.60
HZY12-60	17.7	13.0	10.54	8.96	7.90	7.03	6.35	5.38	4.62	2.90
HZY12-70	23.0	15.9	12.3	10.1	8.60	7.51	6.70	5.82	4.76	3.15
HZY12-80	27.0	18.8	14.6	12.1	10.4	9.09	8.11	6.75	5.82	3.87
HZY12-90	30.5	21.4	16.6	13.6	11.6	10.1	8.99	7.45	6.39	4.23
HZY12-100	31.4	22.1	17.3	14.2	12.0	10.8	9.6	8.01	6.90	4.57
HZY12-110	35.7	25.0	19.5	16.1	13.9	12.2	10.9	9.07	7.88	5.29
HZY12-115	39.2	28.2	22.3	18.5	16.0	14.1	12.7	10.58	9.06	5.81
HZY12-120	39.8	28.2	22.0	18.1	15.5	13.7	12.3	10.2	8.76	5.74
HZY12-135	47.4	33.9	26.7	22.0	18.9	16.5	14.7	12.1	10.4	6.88
HZY12-150	50.3	35.1	27.2	22.4	19.3	16.9	15.2	12.7	10.9	7.35
HZY12-160	57.1	39.9	31.2	25.7	22.1	19.3	17.3	14.3	12.2	7.84
HZY12-200	67.2	47.5	37.0	30.5	26.1	22.9	20.5	17.1	14.7	9.8
HZY12-230	75.4	53.2	41.7	34.6	29.7	26.2	23.5	19.6	16.9	11.3
HZY6-110	36.8	25.9	20.1	16.7	14.3	12.7	11.3	9.43	8.16	5.46
HZY6-155	61.2	44.0	34.8	29.0	25.1	22.2	20.0	16.80	14.55	9.60
HZY6-160	59.6	41.8	32.6	27.0	23.2	20.3	18.3	15.2	13.1	8.72
HZY6-200	67.4	47.8</								



# HAZE Watts Per Cell Data

Battery Model	Time in Minutes - Watts per cell to 1.85 VPC														
	5	10	15	20	25	30	35	40	45	60	90	120	180	240	
HZY6-7.5	26.9	19.4	16.1	13.7	12.0	10.8	9.79	9.01	8.41	6.98	5.30	4.28	3.07	2.44	
HZY6-10	39.8	29.3	24.5	21.2	18.6	16.7	15.1	13.8	12.8	10.5	7.87	6.32	4.48	3.52	
HZY6-12	46.5	35.0	29.3	25.7	22.7	20.3	18.5	16.9	15.7	12.9	9.68	7.81	5.62	4.38	
HZY12-7.5	26.9	19.4	16.1	13.7	12.0	10.8	9.79	9.01	8.41	6.98	5.30	4.28	3.07	2.44	
HZY12-12	46.5	35.0	29.3	25.7	22.7	20.3	18.5	16.9	15.7	12.9	9.68	7.81	5.62	4.38	
HZY12-18	69.4	49.3	41.1	35.5	31.3	28.0	25.4	23.2	21.6	17.8	13.5	10.9	7.98	6.24	
HZY12-26	105	79.4	66.9	57.5	50.6	45.2	41.1	37.4	34.6	27.9	20.4	16.5	12.2	9.77	
HZY12-33	140	104	86.9	75.0	65.7	58.5	52.7	48.0	44.2	35.2	25.0	19.5	13.6	10.5	
HZY12-44	171	136	116	98.0	85.8	76.3	69.1	62.9	57.8	46.6	33.5	26.2	18.2	13.9	
HZY12-55	213	161	134	115	101	89.9	81.7	74.7	69.2	56.1	41.0	32.3	23.0	18.1	
HZY12-60	257	192	160	137	120	106	94.9	86.4	78.8	64.1	48.2	39.0	29.8	24.3	
HZY12-70J	242	192	167	145	130	118	108	100	93.1	75.8	54.7	42.5	29.5	22.7	
HZY12-70	251	199	171	150	133	120	110	101	93.7	76.7	55.3	43.1	30.1	23.2	
HZY12-80	264	215	184	162	144	131	121	112	105	86.2	62.7	49.1	34.3	26.7	
HZY12-90	308	247	211	184	162	146	134	124	115	95.3	70.7	56.1	39.7	30.9	
HZY12-100	340	271	232	203	181	163	148	137	127	104	76.5	60.3	42.6	33.4	
HZY12-110	371	302	261	228	202	183	166	151	140	113	83.3	66.3	46.7	36.3	
HZY12-115	456	346	293	259	233	208	189	172	158	130	97.0	78.8	58.6	46.8	
HZY12-120	418	352	300	260	230	208	189	174	161	131	95.7	75.8	53.0	41.0	
HZY12-135	385	320	295	271	250	230	214	199	185	154	112	88.1	60.8	46.6	
HZY12-150	451	378	330	299	271	251	230	213	197	162	119	93.4	64.9	50.3	
HZY12-160	438	389	348	314	288	267	248	231	216	180	133	106	74.2	57.9	
HZY12-200	464	439	396	359	330	309	290	272	256	212	156	123	87.7	69.1	
HZY12-230	539	476	426	389	358	334	313	296	281	240	177	140	99.0	77.6	
HZY6-110	392	315	274	239	213	190	172	157	145	117	85.7	67.9	47.8	37.3	
HZY6-155	477	403	366	333	303	281	260	242	227	191	149	122	90.0	69.9	
HZY6-160	455	405	362	331	306	283	264	245	230	189	139	109	76.5	59.9	
HZY6-200	487	428	382	349	321	301	282	264	250	210	153	120	86.2	68.1	

Battery Model	Time in Minutes - Watts per cell to 1.80 VPC														
	5	10	15	20	25	30	35	40	45	60	90	120	180	240	
HZY6-7.5	31.1	21.4	17.5	14.8	12.9	11.5	10.3	9.52	8.83	7.28	5.51	4.44	3.18	2.52	
HZY6-10	44.2	31.9	26.5	22.7	19.8	17.6	15.9	14.5	13.4	11.0	8.27	6.60	4.69	3.66	
HZY6-12	53.7	37.7	30.8	26.9	23.6	21.2	19.3	17.6	16.3	13.4	10.0	8.07	5.78	4.52	
HZY12-7.5	31.1	21.4	17.5	14.8	12.9	11.5	10.3	9.52	8.83	7.28	5.51	4.44	3.18	2.52	
HZY12-12	53.7	37.7	30.8	26.9	23.6	21.2	19.3	17.6	16.3	13.4	10.0	8.07	5.78	4.52	
HZY12-18	77.0	52.9	43.4	37.1	32.5	29.2	26.3	24.0	22.2	18.2	13.8	11.1	8.11	6.35	
HZY12-26	118	87.0	71.0	60.6	52.8	47.1	42.7	38.8	35.8	28.8	21.0	16.9	12.5	10.0	
HZY12-33	152	112	91.4	78.0	68.0	60.0	54.1	49.1	45.1	36.0	25.5	19.9	13.9	10.8	
HZY12-44	189	147	121	102	88.4	78.3	70.7	64.3	58.9	47.3	34.0	26.5	18.4	14.2	
HZY12-55	232	172	142	121	105	93.6	84.3	77.1	71.2	57.6	41.9	33.0	23.6	18.6	
HZY12-60	280	205	171	144	126	111	100	90.6	82.7	66.9	50.1	40.4	30.4	24.5	
HZY12-70J	270	204	176	152	134	121	111	102	95.3	77.0	55.4	43.0	29.9	23.1	
HZY12-70	275	213	180	156	138	124	113	104	96.5	78.3	56.3	43.8	30.6	23.6	
HZY12-80	288	231	196	168	150	136	124	115	108	88.4	64.1	50.1	35.0	27.2	
HZY12-90	341	268	225	194	170	152	139	128	119	97.7	72.2	57.1	40.3	31.3	
HZY12-100	396	299	250	215	189	169	154	142	131	107	78.3	61.9	43.6	34.1	
HZY12-110	432	336	282	240	213	190	171	157	145	116	85.3	67.6	47.5	37.2	
HZY12-115	514	392	325	279	247	221	199	182	165	134	100	81.3	60.5	48.2	
HZY12-120	464	371	315	271	238	214	195	179	165	134	98.0	77.3	54.0	41.9	
HZY12-135	469	363	319	285	259	238	221	204	191	157	114	89.7	61.9	47.5	
HZY12-150	525	415	357	317	287	262	239	221	204	167	122	95.2	65.9	51.2	
HZY12-160	504	427	375	333	303	280	259	240	224	185	136	108	75.8	59.2	
HZY12-200	576	497	434	386	352	327	304	284	266	220	162	127	90.3	71.1	
HZY12-230	612	530	460	416	380	351	328	308	291	246	181	143	100.5	78.7	
HZY6-110	439	343	291	250	220	196	176	161	148	119	87.1	69.0	48.5	37.9	
HZY6-155	584	459	401	356	322	296	274	255	237	198	154	126	92.3	71.7	
HZY6-160	563	461	400	358	326	300	278	257	240	195	142	112	78.3	61.4	
HZY6-200	595	480	416	374	343	319	297	279	261	217	157	125	89.3	70.7	

Battery Model	Time in Minutes - Watts per cell to 1.75 VPC														
	5	10	15	20	25	30	35	40	45	60	90	120	180	240	
HZY6-7.5	33.2	22.9	18.4	15.5	13.4	11.9	10.8	9.87	9.13	7.49	5.65	4.53	3.23	2.56	
HZY6-10	47.1	33.6	27.6	23.5	20.4	18.1	16.4	14.9	13.8	11.3	8.47	6.78	4.84	3.75	
HZY6-12	57.3	40.0	32.4	27.8	24.4	21.7	19.7	18.0	16.6	13.7	10.2	8.20	5.87	4.60	
HZY12-7.5	33.2	22.9	18.4	15.5	13.4	11.9	10.8	9.87	9.13	7.49	5.65	4.53	3.23	2.56	
HZY12-12	57.3	40.0	32.4	27.8	24.4	21.7	19.7	18.0	16.6	13.7	10.2	8.20	5.87	4.60	
HZY12-18	81.5	55.1	45.1	38.4	33.4	29.8	26.9	24.4	22.6	18.5	14.0	11.3	8.20	6.45	
HZY12-26	125	91.4	73.7	62.2	54.0	47.9	43.3	39.5	36.3	29.2	21.2	17.1	12.7	10.2	
HZY12-33	161	116	94.5	79.8	69.0	60.9	54.7	49.7	45.6	36.4	25.8	20.1	14.1	11.0	
HZY12-44	197	151	125	105	90.4	79.7	72.0	65.2	59.9	48.0	34.5	26.9	18.7	14.4	
HZY12-55	240	177	146	123	107	95.2	85.7	78.4	72.3	58.2	42.3	33.4	23.8	18.8	
HZY12-60	292	218	178	151	130	115	102	92.8	84.7	68.3	50.7	40.9	30.9	25.0	
HZY12-70J	284	216	183	157	138	125	113	104	96.9	78.2	56.1	43.4	30.2	23.3	
HZY12-70	290	222	186	161	142	127	116	106	98.3	79.2	56.9	44.3	31.0	23.9	
HZY12-80	304	242	204	174	155	140	128	118	110	89.9	65.1	50.9	35.3	27.5	
HZY12-90	366	283	235	202	176	157	143	131	122	99.4	73.3	58.2	41.1	32.0	
HZY12-100	429	310	258	220	193	172	157	144	133	109	79.3	62.7	44.3	34.7	
HZY12-110	468	352	291	247	217	193	174	159	146	118	86.3	68.4	48.2	37.6	
HZY12-115	552	415	343	294	257	229	205	186	170	137	102	83.0	61.5	49.1	
HZY12-120	494	388	325	277	242	218	198	182	168	136	99.1	78.3	54.8	42.4	
HZY12-135	518	381	328	292	264	240	223	208	195	159	115	90.7	62.8	48.3	
HZY12-150	568	434	369	325	293	267	244	224	208	169	123	96.3	66.8	51.9	
HZY12-160	556	450	391	345	314	289	267	246	229	188	138	110	77.1	60.4	
HZY12-200	629	524	456	406	368	340	315	294	274	226	165	129	91.7	72.3	
HZY12-230	668	559	482	432	391	360	336	314	296	249	183	144	102	79.7	
HZY6-110	478	357	300	257	225	200	180	164	151	121	88.0	69.8	49.1	38.4	
HZY6-155	662	495	423	373	335	305	283	262	244	203	157	129	94.1	73.0	
HZY6-160	630	480	415	370	336	307	284	262	244	199	144	113	79.2	62.2	
HZY6-200	641	505	432	389	353	327	305	286	267	221	160	126	90.9	72.1	

Battery Model	Time in Minutes - Watts per cell to 1.70 VPC													
	5	10	15	20	25	30	35	40	45	60	90	120	180	240
HZY6-7.5	35.3	24.3	19.2	16.0	13.8	12.3	11.0	10.0	9.33	7.65	5.73	4.59	3.28	2.59
HZY6-10	50.1	35.2	28.3	24.0	20.7	18.4	16.6	15.1	13.9	11.4	8.60	6.88	4.91	3.81
HZY6-12	60.9	41.5	33.7	28.6	24.7	22.1	20.0	18.3	16.9	13.8	10.3	8.28	5.96	4.68
HZY12-7.5	35.3	24.3	19.2	16.0	13.8	12.3	11.0	10.0	9.33	7.65	5.73	4.59	3.28	2.59
HZY12-12	60.9	41.5	33.7	28.6	24.7	22.1	20.0	18.3	16.9	13.8	10.3	8.28	5.96	4.68
HZY12-18	85.1	57.1	46.3	39.1	34.0	30.3	27.3	24.9	23.0	18.8	14.1	11.4	8.30	6.54
HZY12-26	134	95.3	76.4	63.5	54.8	48.7	43.9	40.0	36.8	29.6	21.4	17.3	12.8	10.4
HZY12-33	168	120	96.7	81.3	70.0	61.7	55.3	50.3	46.1	36.7	26.1	20.3	14.3	11.2
HZY12-44	203	156	128	107	91.6	81.1	72.8	66.2	60.6	48.4	34.8	27.2	18.9	14.6
HZY12-55	253	184	149	125	109	96.8	87.3	79.3	73.2	58.8	42.7	33.7	24.0	19.0
HZY12-60	302	231	184	154	133	116	104	93.9	85.5	68.9	51.2	41.4	31.4	25.5
HZY12-70J	298	226	189	161	142	127	115	106	98.5	79.3	56.8	43.8	30.4	23.5
HZY12-70	304	229	190	164	144	129	118	107	99.6	80.0	57.5	44.7	31.2	24.0
HZY12-80	324	254	211	180	158	143	130	120	112	90.8	65.7	51.3	35.6	27.7
HZY12-90	388	295	243	207	180	160	146	133	124	101	74.1	58.9	41.6	32.4
HZY12-100	449	324	266	225	197	176	159	146	135	110	80.2	63.3	44.6	34.9
HZY12-110	492	365	299	252	222	197	177	161	148	119	87.3	69.2	48.7	38.1
HZY12-115	591	436	356	302	264	234	209	189	172	139	104	84.1	62.3	49.8
HZY12-120	522	403	334	284	248	222	201	185	170	137	100	79.1	55.2	42.8
HZY12-135	543	392	333	297	267	246	227	212	197	161	117	92.2	63.6	49.0
HZY12-150	604	452	380	334	301	272	248	228	211	171	125	97.2	67.4	52.5
HZY12-160	589	472	405	357	323	296	271	251	233	190	140	111	77.8	61.0
HZY12-200	688	561	480	422	381	349	323	299	280	230	167	131	92.9	73.0
HZY12-230	720	587	498	443	400	368	342	319	301	252	184	146	103	80.5
HZY6-110	504	369	307	261	228	202	182	166	153	122	88.9	70.7	49.8	38.9
HZY6-155	728	529	443	387	347	315	290	268	248	207	159	130	95.1	74.0
HZY6-160	654	500	429	378	343	312	288	266	247	201	146	114	80.0	62.8
HZY6-200	680	527	443	397	360	333	310	290	271	224	162	128	92.1	72.9

Battery Model	Time in Minutes - Watts per cell to 1.65 VPC													
	5	10	15	20	25	30	35	40	45	60	90	120	180	240
HZY6-7.5	36.3	25.2	19.8	16.4	14.1	12.5	11.3	10.3	9.51	7.78	5.82	4.65	3.32	2.62
HZY6-10	52.2	36.5	29.0	24.5	21.1	18.7	16.8	15.3	14.1	11.5	8.69	6.96	4.95	3.85
HZY6-12	63.2	42.7	34.3	29.0	25.0	22.3	20.2	18.4	17.0	13.9	10.4	8.35	6.00	4.71
HZY12-7.5	36.3	25.2	19.8	16.4	14.1	12.5	11.3	10.3	9.51	7.78	5.82	4.65	3.32	2.62
HZY12-12	63.2	42.7	34.3	29.0	25.0	22.3	20.2	18.4	17.0	13.9	10.4	8.35	6.00	4.71
HZY12-18	88.6	58.6	47.2	39.8	34.5	30.6	27.5	25.2	23.2	19.1	14.3	11.5	8.39	6.65
HZY12-26	142	98.6	78.2	65.3	56.2	49.8	44.7	40.6	37.3	30.0	21.7	17.5	13.0	10.5
HZY12-33	177	123	98.7	82.8	71.2	62.5	56.1	50.8	46.5	37.1	26.3	20.4	14.5	11.4
HZY12-44	209	159	130	108	92.6	81.8	73.4	66.8	61.1	48.8	35.1	27.4	19.0	14.7
HZY12-55	262	190	152	127	110	98.0	88.4	80.1	73.9	59.6	43.2	34.1	24.3	19.1
HZY12-60	313	237	188	157	134	118	105	94.5	85.9	69.2	51.5	41.6	31.5	25.6
HZY12-70J	314	234	194	165	144	129	117	108	99.7	80.2	57.3	44.3	30.8	23.7
HZY12-70	315	233	192	166	145	130	118	109	101	80.8	57.9	45.0	31.4	24.2
HZY12-80	355	264	217	185	162	145	133	122	113	91.9	66.2	51.8	36.0	27.9
HZY12-90	410	304	249	212	184	163	149	135	125	102	74.8	59.5	42.0	32.7
HZY12-100	473	335	270	229	200	178	161	148	137	111	80.7	63.7	44.9	35.2
HZY12-110	518	379	306	257	225	199	179	163	150	120	88.1	69.8	49.1	38.4
HZY12-115	615	451	365	308	269	237	212	192	174	141	105	84.9	63.1	50.2
HZY12-120	545	415	341	288	251	225	204	187	172	139	101	79.7	55.5	43.0
HZY12-135	565	421	353	310	277	253	232	215	200	164	119	93.1	64.2	49.4
HZY12-150	626	467	390	342	306	276	252	232	214	173	126	97.9	67.9	52.9
HZY12-160	632	491	416	365	328	301	276	254	236	193	141	112	78.3	61.5
HZY12-200	746	586	498	435	390	357	330	306	285	234	169	133	94.0	74.1
HZY12-230	770	602	511	451	408	373	347	323	304	256	188	147	104	81.5
HZY6-110	521	379	313	266	231	205	184	168	154	123	89.8	71.3	50.3	39.2
HZY6-155	775	554	457	400	357	323	296	272	252	210	160	132	96.0	74.6
HZY6-160	688	516	438	386	348	316	291	269	249	203	147	115	80.8	63.4
HZY6-200	720	547	458	406	366	338	314	294	275	227	163	129	92.9	73.5

Battery Model	Time in Minutes - Watts per cell to 1.60 VPC													
	5	10	15	20	25	30	35	40	45	60	90	120	180	240
HZY6-7.5	38.4	26.3	20.4	16.8	14.4	12.8	11.5	10.5	9.63	7.89	5.88	4.70	3.34	2.63
HZY6-10	54.6	37.9	29.7	24.9	21.5	19.0	17.0	15.5	14.3	11.6	8.77	7.02	5.00	3.89
HZY6-12	66.4	43.6	35.0	29.3	25.3	22.5	20.3	18.6	17.2	14.0	10.5	8.42	6.03	4.74
HZY12-7.5	38.4	26.3	20.4	16.8	14.4	12.8	11.5	10.5	9.63	7.89	5.88	4.70	3.34	2.63
HZY12-12	66.4	43.6	35.0	29.3	25.3	22.5	20.3	18.6	17.2	14.0	10.5	8.42	6.03	4.74
HZY12-18	91.6	60.1	48.1	40.3	34.8	30.9	27.9	25.4	23.5	19.2	14.5	11.7	8.46	6.71
HZY12-26	150	102	80.2	66.7	57.4	50.7	45.6	41.4	38.0	30.5	22.1	17.7	13.2	10.8
HZY12-33	183	126	100	83.9	72.0	63.3	56.7	51.5	47.1	37.5	26.6	20.7	14.7	11.6
HZY12-44	215	162	132	110	94.0	82.8	74.2	67.4	61.6	49.2	35.3	27.6	19.1	14.8
HZY12-55	274	194	154	130	112	99.4	89.7	81.3	74.9	60.2	43.7	34.4	24.5	19.3
HZY12-60	321	242	190	159	136	119	106	95.2	86.4	69.6	51.7	41.9	31.7	25.7
HZY12-70J	331	242	199	168	146	131	119	109	101	81.0	58.0	44.7	31.1	23.9
HZY12-70	330	239	195	167	147	132	119	110	101	81.3	58.3	45.3	31.6	24.4
HZY12-80	378	272	223	188	165	147	134	123	115	92.8	66.7	52.2	36.3	28.1
HZY12-90	431	313	255	215	187	166	151	138	127	103	75.7	60.2	42.6	33.2
HZY12-100	497	345	276	233	204	180	164	150	139	112	81.5	64.3	45.4	35.5
HZY12-110	540	390	312	263	229	203	182	165	152	122	89.2	70.3	49.5	38.6
HZY12-115	634	464	373	313	272	240	215	194	176	142	105	85.7	63.7	50.7
HZY12-120	572	427	346	292	254	227	206	189	174	140	102	80.4	56.1	43.5
HZY12-135	607	438	364	316	281	257	235	217	202	166	120	94.0	64.7	49.9
HZY12-150	652	480	400	348	311	280	255	234	216	175	126	98.6	68.4	53.3
HZY12-160	676	508	426	371	334	305	280	257	239	195	142	112	78.9	61.9
HZY12-200	792	609	510	447	398	363	335	311	289	236	171	134	95.0	74.6
HZY12-230	834	625	526	459	414	379	351	327	308	259	190	149	105	82.4
HZY6-110	539	389	318	269	234	207	186	169	155	124	90.7	71.9	50.6	39.5
HZY6-155	806	566	467	405	362	327	299	274	254	213	162	133	97.0	75.3
HZY6-160	720	534	448	395	354	321	295	271	252	205	148	116	81.4	63.8
HZY6-200	760	562	472	416	374	344	319	298	278	229	165	130	93.6	73.9

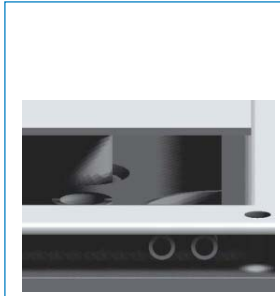

**Central Gassing** - Haze produce some models with a integral central gassing system. This system is a useful feature when batteries are installed in an IP66 cabinet. Sealing prevents any escaping gas from exiting the enclosure. Central gassing allows a tube carrying the emissions to pass through a seal to atmosphere. Haze are adding this feature to a number of sizes, if you require this feature please contact us for an up-to-date list of models included.

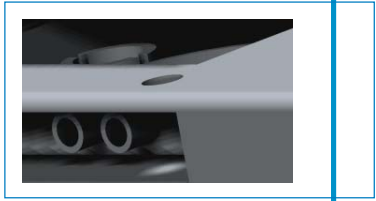

Battery Model	Qty Per Box	Dimensions (mm) & weight (Kg)				Dimensions (Inches) & weight (Lbs)				Terminal Details	BCI Group Size	Internal Resistance mOhms	Maximum Charge Current	CCA at 0 °C	Short Circuit Amps
		Length	Width	Height	Weight	Length	Width	Height	Weight						
HZY6-7.5	10	150	34	96 (101)	1.3	5.91	1.34	3.7 (3.9)	2.8	B-T1	-	13	1.5	NA	275
HZY6-10	10	151	50	96 (101)	1.9	5.94	1.97	3.7 (3.9)	4.2	B-T1	-	10	2	NA	325
HZY6-12	10	151	50	96 (101)	2.0	5.94	1.97	3.7 (3.9)	4.4	B-T2	-	10	2.4	NA	500
HZY12-7.5	8	151	65	96 (101)	2.5	5.94	2.56	3.7 (3.9)	5.5	D-T1	-	28	1.5	NA	275
HZY12-12	4	150	97	98 (103)	4.0	5.91	3.82	3.7 (3.9)	8.8	D-T2	-	20	2.4	NA	500
HZY12-18	2	181	76	167	5.9	7.13	2.99	6.57	13.0	C - M5	-	12	4.5	270	700
HZY12-26	1	166	176	126	8.8	6.54	6.93	4.96	19.4	C - M5	-	9.5	6.5	300	900
HZY12-33	1	195	130	160	10.9	7.68	5.12	6.30	24.1	B - M6	U1	8.5	8	320	1100
HZY12-44	1	197	165	170	14.0	7.76	6.50	6.69	30.9	C - M6	-	7.5	11	350	1400
HZY12-55	1	228	137	207	17.5	8.98	5.39	8.15	38.7	B - M6	22NF	6.5	14	380	1700
HZY12-60	1	228	139	217	18.3	8.98	5.47	8.54	40.4	B - M6	-	6.5	14	410	1750
HZY12-70J	1	350	167	179	22.1	13.78	6.57	7.05	48.8	Flag 1/4" C - M6	-	5	18	550	2100
HZY12-70	1	259	168	208	21.5	10.20	6.61	8.19	47.5	B - M6	24	5	18	550	2100
HZY12-80	1	259	168	208	23.3	10.20	6.61	8.19	51.5	B - M6	24	5	20	620	2400
HZY12-90	1	305	168	208	27	12.01	6.61	8.19	59.7	B - M6	27	4	22	680	2650
HZY12-100	1	305	168	208	28.4	12.01	6.61	8.19	62.8	B - M6	27	5	25	780	2900
HZY12-110	1	332	174	213	32.2	13.07	6.85	8.39	71.2	B - M6	31	4	27	960	3000
HZY12-115	1	349	174	217	37.0	13.74	6.85	8.54	81.8	B - M6	-	4	28	980	3100
HZY12-120	1	408	176	227	35.4	16.06	6.93	8.94	78.2	B - M6	-	3	30	1020	3300
HZY12-135	1	340	173	280	39.8	13.39	6.81	11.02	88.0	C - M6	-	2.5	35	1160	3750
HZY12-150	1	482	170	242	44.3	18.98	6.69	9.53	97.8	B - M6	-	2	38	1300	4200
HZY12-160	1	530	209	214	57.4	20.87	8.23	8.43	126.9	E - M6	4D	2	40	1440	4700
HZY12-200	1	520	240	220	66.0	20.47	9.45	8.66	145.9	E - M8	-	<2	50	1670	5400
HZY12-230	1	521	269	203	71.0	20.51	10.59	7.99	156.9	E - M8	8D	<2	57	1870	5900
HZY6-110	1	193	168	205	16.0	7.60	6.61	8.07	35.4	A - M6	-	4	27	1010	3200
HZY6-155	1	282	176	282	37.0	11.10	6.93	11.10	81.8	A - M6	-	<2	45	1590	4900
HZY6-160	1	298	171	226	26.0	11.73	6.73	8.90	57.5	A - M6	-	2	40	1290	4600
HZY6-200	1	318	178	225	31.0	12.52	7.01	8.86	68.5	A - M8	-	<2	50	1600	5000

Standard terminal is threaded insert style

**Terminal Layout details**

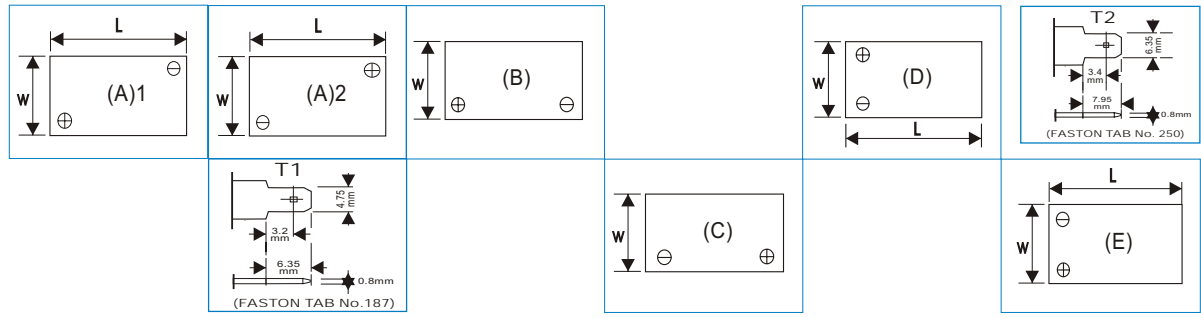

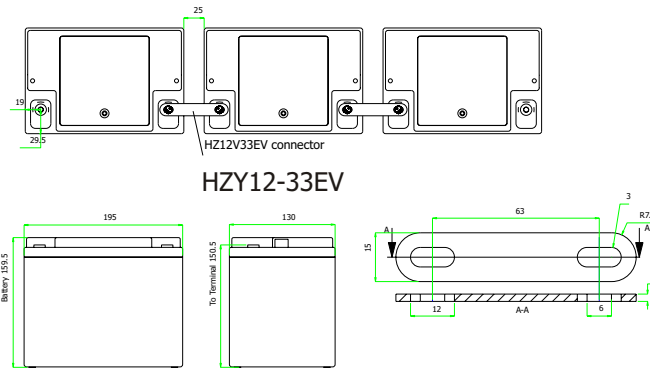

Battery installations have many variables : space available, autonomy times, load carrying requirements etc.

Haze Engineering department is at the customers disposal to find the best solution, provide dimensioned layout drawings and wiring diagrams.

A tailor made solution to meet the customers requirements.

All drawings are submitted for customer approval to ensure trouble free installation.

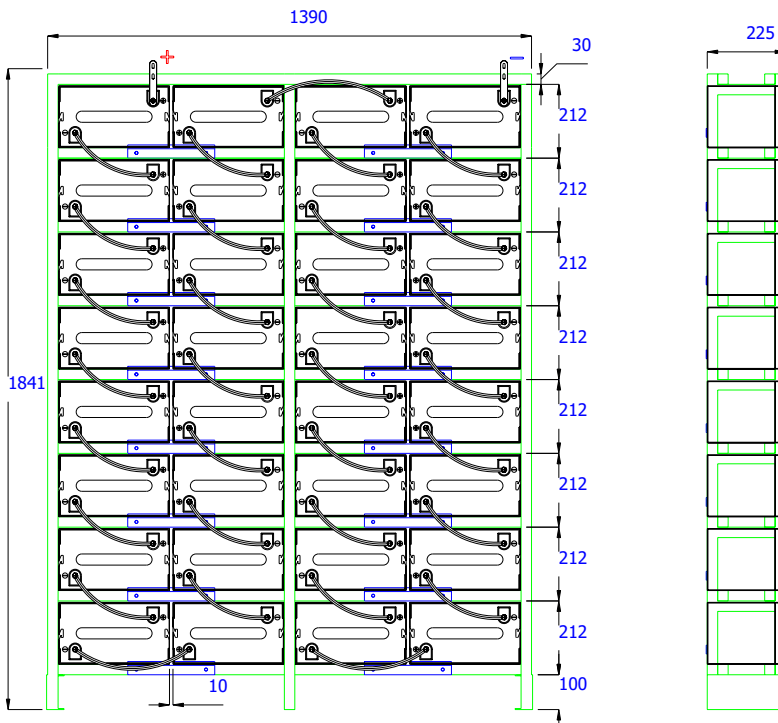
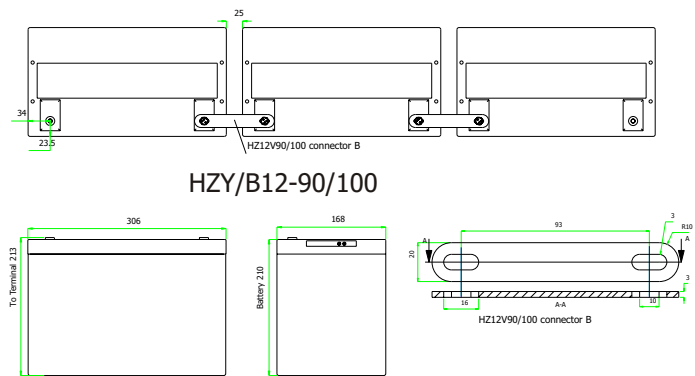

Racking is available to suit available space and required configuration.

Special cables and / or standard connectors can be provided on request along with wiring diagrams.

A range of terminal covers are available to cover large and small batteries and cables or connectors.

The example rack shown is for HZB/Y6-200.



020207

#### VRLA Product Range

4, 6 & 12 Volt AGM 1.3 to 230AH

6 & 12 Volt Gel 7.5 to 230AH

12 Volt Front Access AGM

12 Volt Front Access Gel

2 Volt AGM & Gel 50 to 3850AH

EV Gel

EV AGM

Marine Gel

Solar



**Electric  
Vehicle  
Gel**

**HAZE**

**POWER TO KEEP  
YOU ON THE MOVE**

**ELECTRIC VEHICLE**  
applications are wide and  
varied with many durability  
& power demands placed  
firmly on the batteries  
shoulders.



**HAZE ELECTRIC  
VEHICLE GEL** always  
delivers when you need it,  
whatever your DC  
requirement in extreme  
situations.



**Tough ABS case with INSERT  
TERMINALS** as standard, smaller  
sizes with **FASTON**.



**Gel Technology** delivers cranking  
amps, general power and long/deep  
discharges without the need for  
immediate recharge. **EXTRA LONG  
CYCLE LIFE** and resistance to  
mechanical stress and the elements  
all in one battery.



**HAZE ELECTRIC VEHICLE GEL** delivers maximum  
capacity within twenty cycles and keeps delivering  
long after the others are on the scrap heap. HAZE  
R&D has resulted in **SPECIAL CHEMICAL** and **PROCESS**  
technology to ensure consistency and performance.



The Quality & Management system governing the manufacture of this product is ISO 9001:2000 and ISO 14001:2004 certified.



**Important Note:** The capacities and runtimes quoted below are applicable to a battery which has achieved full capacity. Full capacity is achieved after approx. 20 cycles. Initial capacity will be approx. 15 - 20% lower.

Battery Model	Dimensions (mm) & weight (Kg)			Cold Cranking Amps			Thread size mm	Reserve Capacity - Minutes Discharged					Capacity - Ampere Hour*							
	Length	Width	Height	Weight	20°C (68°F)	0°C (32°F)		-18°C (68°F)	75 Amps	25 Amps	20 Amps	15 Amps	8 Amps	100 Hr	48 Hr	20 Hr	10 Hr	5 Hr	3 Hr	1 Hr
					Volts	Volts		Volts						100 Hr	48 Hr	20 Hr	10 Hr	5 Hr	3 Hr	1 Hr
HZY-EV6-7.5	149	34	94	1.3	-	-	-	6	NA	-	-	-	8.6	8.1	7.5	6.9	6.1	5.6	4.6	
HZY-EV6-10	151	50	95	1.8	-	-	-	6	NA	-	-	-	11.6	10.9	10.1	9.2	8.2	7.6	6.2	
HZY-EV6-12	151	50	95	2.0	-	-	-	6	NA	-	-	-	13.8	13.0	12.0	11.0	9.8	9.0	7.4	
HZY-EV12-7.5	150	63	95	2.5	-	-	-	12	NA	-	-	-	8.6	8.1	7.5	6.9	6.1	5.6	4.6	
HZY-EV12-12	152	99	96	4.0	-	-	-	12	NA	-	-	-	13.8	13.0	12.0	11.0	9.8	9.0	7.4	
HZY-EV12-18	181	76	167	5.4	204	137	84	12	5	-	26	44	91	19	18	17	15	14	13	10
HZY-EV12-26	168	178	124	8.0	301	217	142	12	5	-	23	41	65	28	26	25	22	20	18	15
HZY-EV12-33	196	131	160	10.4	350	260	172	12	6	6.9	30	52	75	34	32	29	27	24	23	18
HZY-EV12-44	198	167	157	13.0	450	337	220	12	6	12	54	78	113	44	41	38	36	32	29	24
HZY-EV12-55	229	138	213	18.4	569	444	294	12	6	19	84	118	165	60	56	52	48	42	39	32
HZY-EV12-70J	349	168	175	21.0	663	530	367	12	6	27	115	156	214	77	72	67	61	54	50	41
HZY-EV12-65	272	165	188	21.5	708	573	400	12	6	31	132	176	246	85	79	74	67	60	55	45
HZY-EV12-80	260	168	211	25.1	740	600	425	12	8	32	141	191	265	89	84	78	71	65	59	49
HZY-EV12-100	306	168	211	29.3	820	715	520	12	8	44	171	225	318	108	102	94	86	77	71	58
HZY-EV12-110	329	173	209	32.2	854	766	560	12	8	48	184	248	356	116	110	102	94	84	77	63
HZY-EV12-120	409	177	225	36.0	917	835	650	12	8	60	221	282	406	135	127	118	108	96	88	73
HZY-EV12-135	342	173	282	43.7	998	906	762	12	8	82	270	361	509	163	153	142	130	116	107	88
HZY-EV12-150	483	170	242	45.5	1011	919	784	12	8	86	282	376	529	169	159	147	135	120	111	91
HZY-EV12-160	530	209	214	53.7	1028	938	811	12	8	93	312	406	570	180	169	157	143	128	118	97
HZY-EV12-200	522	242	220	63.4	1094	988	909	12	8	139	429	553	780	235	222	210	192	167	158	129
HZY-EV12-230	521	270	205	69.5	1117	1007	940	12	8	164	517	664	897	276	259	240	220	195	181	149
HZY-EV6-110	193	168	204	17.1	880	789	577	6	8	52	205	263	365	126	119	110	100	89	83	68
HZY-EV6-160	298	171	226	26.5	1059	966	835	6	8	109	335	435	612	192	180	167	152	136	125	103
HZY-EV6-180	260	181	246	29.6	1071	972	868	6	8	118	359	465	653	203	191	176	161	144	133	109
HZY-EV6-200	323	178	226	30.2	1083	978	900	6	8	130	394	506	706	219	205	190	174	155	143	118
HZY-EV6-225	244	188	275	33.8	1116	1007	927	6	8	144	453	590	811	248	233	216	197	175	162	133
HZY-EV8-180	260	182	298	34.4	1045	955	829	8	8	113	347	447	647	197	185	172	157	140	129	106

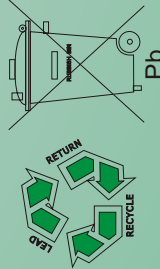

Haze Battery Company keenly encourages environmental awareness; PLEASE follow guidelines for the recycling /disposal of lead.



UL Recognised Component  
MH28512



Website: [www.hazebattery.com](http://www.hazebattery.com)  
E mail : [sales@hazebattery.com](mailto:sales@hazebattery.com)

# Haze Battery Co.,Ltd

XIANGSHUIHE DAYAWAN ECONOMY & TECHNOLOGY  
DEVELOPMENT ZONE HUIZHOU GUANGDONG CHINA 516085  
Tel: 86-752-5189988 Fax: 86-752-5189989  
Email:custserv@hazebattery.com

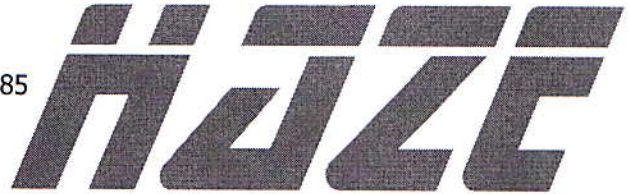

To Whom It May Concern

## Certificate for Non-dangerous Goods(Non-Hazardous)

### **Proper Shipping Name: Dry Battery**

We hereby certify that our batteries are non-dangerous and non-hazardous materials for air transportation in any nature. The consignment is fully described by proper shipping name and packed, marked and in proper condition for carriage by air. We further certify that the consignment is not classified as dangerous under the current edition of the IATA dangerous goods regulations and applicable carrier and governmental regulations.

We also acknowledge that we may be liable for damage resulting from any mistake or omission and we further agree that any sea carrier involved in the carriage of this consignment may rely upon this Certification.

Yours faithfully,

**Haze Battery Co.,Ltd**



**Authorized Signature**



# Haze Battery Co.,Ltd

XIANGSHUIHE DAYAWAN ECONOMY & TECHNOLOGY  
DEVELOPMENT ZONE HUIZHOU GUANGDONG CHINA 516085  
Tel: 86-752-5189988 Fax: 86-752-5189989  
Email:custserv@hazebattery.com



To Whom It May Concern

## Certificate for Non-dangerous Goods(Non-Hazardous)

### **Proper Shipping Name: Dry Battery**

We hereby certify that our batteries are non-dangerous and non-hazardous materials for sea transportation in any nature. The consignment is fully described by proper shipping name and packed, marked and in proper condition for carriage by sea. We further certify that the consignment is not classified as dangerous under the current edition of the IATA dangerous goods regulations and applicable carrier and governmental regulations.

We also acknowledge that we may be liable for damage resulting from any mistake or omission and we further agree that any sea carrier involved in the carriage of this consignment may rely upon this Certification.

Yours faithfully,

**Haze Battery Co.,Ltd**



**Authorized Signature**