

Exceptional Remote Performance

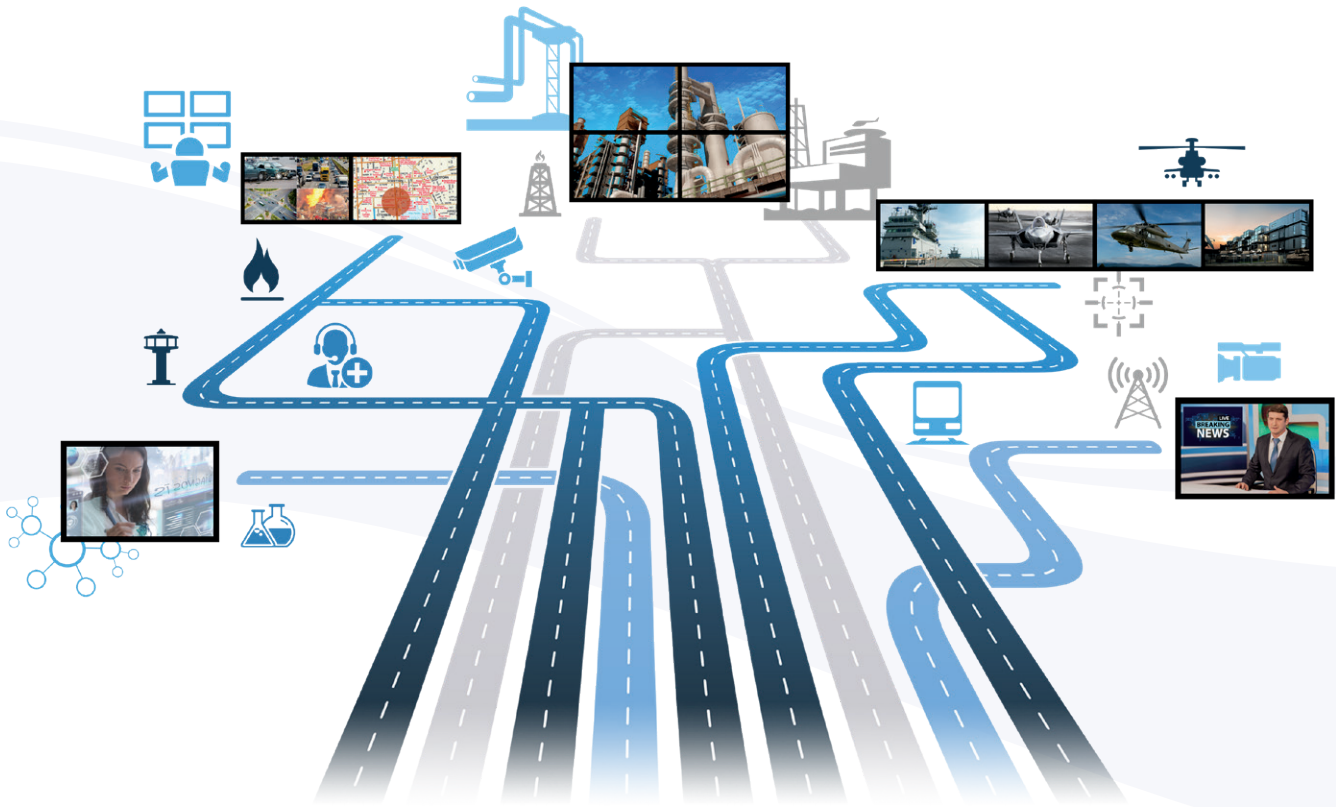

Matrox® Extio™ 3 High-Performance IP KVM Extenders



Superior performance • Ease of integration • Secure installation
Flexible operation • Smart control • Optimized collaboration

Flexible. Secure. Easy

Matrox® Extio™ 3 is the world's first IP KVM extender to deliver 4Kp60 4:4:4 UHD performance and multi-display capabilities at unprecedented low bitrates. Leveraging a standard 1 Gigabit Ethernet (GbE) network, Extio 3 works with commercial off-the-shelf (COTS) network switches and significantly diminishes the total cost of ownership to deliver a scalable KVM matrix switching solution.

Matrox KVM extenders help to centralize hardware in a climate-controlled server room to increase security, protect systems against environmental hazards, and reduce system noise and heat emissions. The Matrox Extio 3 IP KVM extender grants seamless remote access to these secured systems, plus the added benefit of smart control of multiple systems over the IP network. This IP KVM extender is ideally suited for process control, industrial automation, healthcare, transportation, emergency and dispatch centers, military, defense, government, broadcasting and post-production, and many other industries and applications.



Superior performance

- Extend ultra-high resolution desktops (3840x2160 @60Hz) at unprecedented low bitrates with the world's first 4Kp60 4:4:4 IP KVM extender.
- Support quad-monitor configurations (4x 1920x1080 @60Hz) with a single transmitter and receiver pair, improving operator workflow across an expansive multi-monitor workspace.
- Deliver pristine image quality, smooth video playback, and excellent keyboard and mouse responsiveness at a distance with Matrox-patented technology.

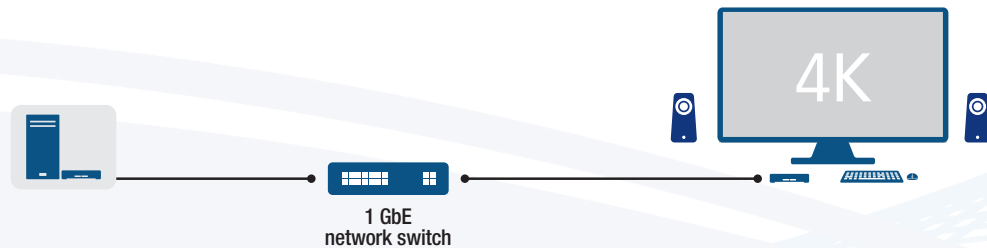

4Kp60 4:4:4 extension over 1GbE at unprecedented low bitrates



Flexible operation

- Deploy as a point-to-point or a networked KVM extender, evolving as needs expand while future-proofing investments.
- Configure over LAN, WAN, or internet networks to support distributed workforces and work-from-home scenarios.
- Transport signals over Cat5e, or optionally upgrade to multimode or single-mode fiber-optic support.
- Create a scalable KVM matrix over IP, supporting one-to-one, one-to-many, many-to-one, or many-to-many configurations.
- Increase efficiency with Aggregator Mode, by controlling multiple systems with a single keyboard and mouse. Work across a multi-monitor workspace and map each system to a screen, or monitor four systems on one 4K display with Tile View.



Point-to-point operation

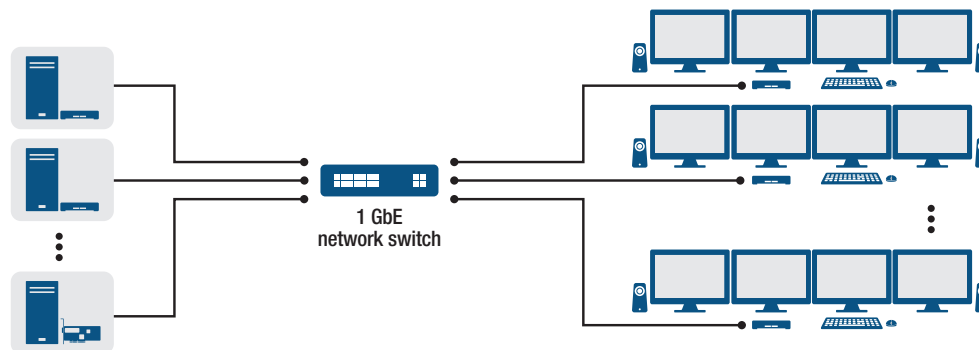

Networked operation



Smart and secure control

- Configure, manage, and monitor all Extio 3 devices from a central location on the network via the Extio Central Manager (ECM) software.
- Select and instantly switch to systems through the on-screen-display (OSD), an intuitive user interface that features the thumbnail previews of available source systems.
- Create a secure KVM installation through a password-protected environment—AES 128-bit hardware encryption ensures safe transmission of all audio, video, and USB signals over the network.
- Integrate with Microsoft® Active Directory Services for user authentication.
- Benefit from an IPSec VPN client for private communications over the internet and multi-factor authentication for enhanced protection against cyber attacks.



Ease of integration

- Leverage existing IT networking equipment and standard Gigabit Ethernet infrastructure for seamless deployment and operations.
- Simplify network management with low bandwidth utilization, as well as boost scalability.
- Guarantee a ready fit into certified systems with plug-and-play deployment—there is no need to install additional software.
- Optimize rack space with two options for the transmitter unit—either a rack-mountable appliance, or an integrated PCIe® card that takes zero rack space.



Optimized collaboration

- Extend systems over standard 1 GbE network—connecting to and controlling systems from any remote location on the IP network—and maximize information flow for improved collaboration and decision making.
- Display Extio 3 video streams on a central video wall powered by Matrox Mura IPX capture and IP encode/decode cards for effective visualization.
- Make use of the proxy-stream*, a secondary video stream compatible with virtually all H.264 decoders—for recording part of the desktop on a network storage device or sharing a screen with other user stations, video walls, and mobile devices.

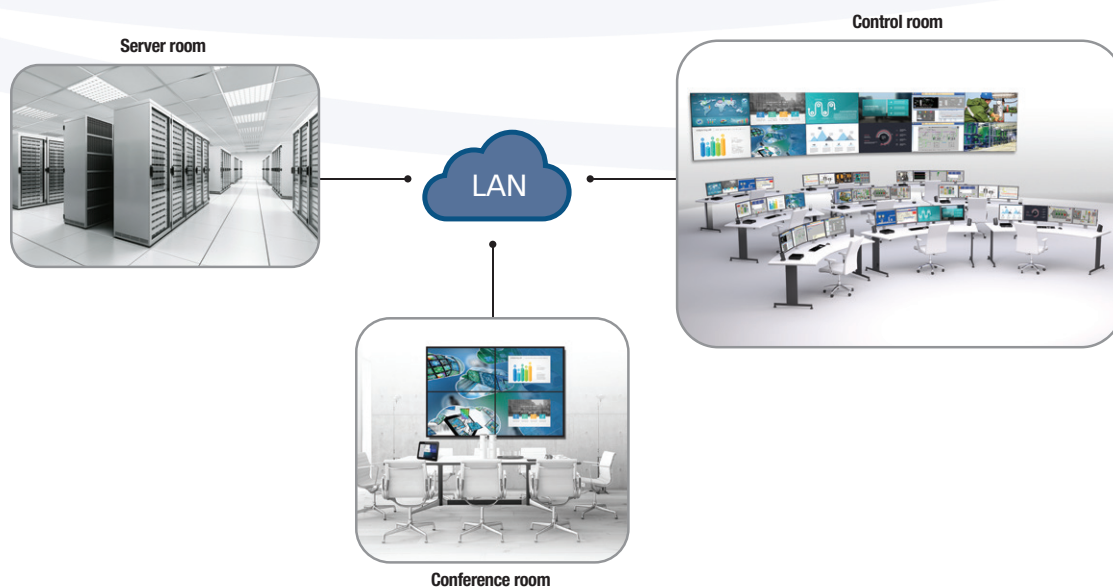

Display Extio 3 video streams on a central video wall for effective visualization

*This feature will be available in a future release.

Easy-to-use Matrox Extio Central Manager software and APIs



Secure, centralized management of all networked Extio 3 IP KVM extenders is overseen through Matrox Extio Central Manager, an easy-to-use software to configure, manage, and monitor Extio 3 transmitter and receiver units. Extio Central Manager delivers smart control over the network, with an intuitive interface that facilitates discovery of networked Extio units, manages connections, and offers options to setup device parameters. A complimentary software, Extio Central Manager works with all networked Extio devices to provide smart control of IP KVM installations.



Device setup

Automatically discover all units on the subnet and manually add units outside the subnet. Assign friendly names to units to easily identify them, and create logical groups of devices to filter views and save time by applying the same settings to multiple units simultaneously. Manage EDID communication between the host system and the displays to simplify deployments. Set up network redundancy for automatic failover operation in the case of a communication link failure.

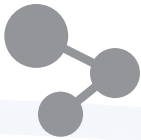

Connection Broker

Create and manage connections between Extio 3 transmitter and receiver units. Connection Broker routes any host system to any remote user station, forming one-to-one, many-to-one, one-to-many, or many-to-many configurations, for easily building a scalable KVM matrix-switching environment over a standard Gigabit network.



Secure access

The password-protected KVM environment protects installations—create and manage user rights directly through Extio Central Manager, or use Microsoft Active Directory Services to manage user authorization authentication. Extio 3 units further safeguard installations by use of HTTPS—a secure communication protocol for sending control commands over the network—and by transmitting AES encrypted audio, video, and USB signals. Extio 3 provides options to support only USB human interface devices (HID) such as keyboard and mouse, and either block all USB 2.0 devices or whitelist approved ones.



Device monitoring

See system functionality at a glance through a vibrant, color-coded visual interface. Log and monitor critical performance parameters, or use the Simple Network Management Protocol (SNMP) for monitoring units through third-party network management software.



Remote access control

Preview authorized computer desktops from the receiver unit through the on-screen-display (OSD), which provides ready connection access to host systems and programmable hotkeys to instantly switch to a favorite system.



Matrox Extio Central Manager APIs and white-label options

Integrators and developers gain command-level access to build personalized Extio Central Manager applications and/or integrate Extio 3 functionality into existing or even third-party applications. White-label options let OEMs and integrators customize the appearance of the Extio Central Manager user interface for easy re-branding of Matrox software with enterprise naming, logos, colors, and identity.



Firmware Updater tool

Separate Extio Firmware Updater tool ensures the most current version of the software is running and allows for system-wide or adapted Extio 3 firmware updates.

Supported operating systems

Microsoft® Windows® 10 (64-bit), Windows 7 (32-bit), Windows 7 (64-bit), Server® 2016, Server 2012 R2, and Server 2008 R2 operating systems are supported.

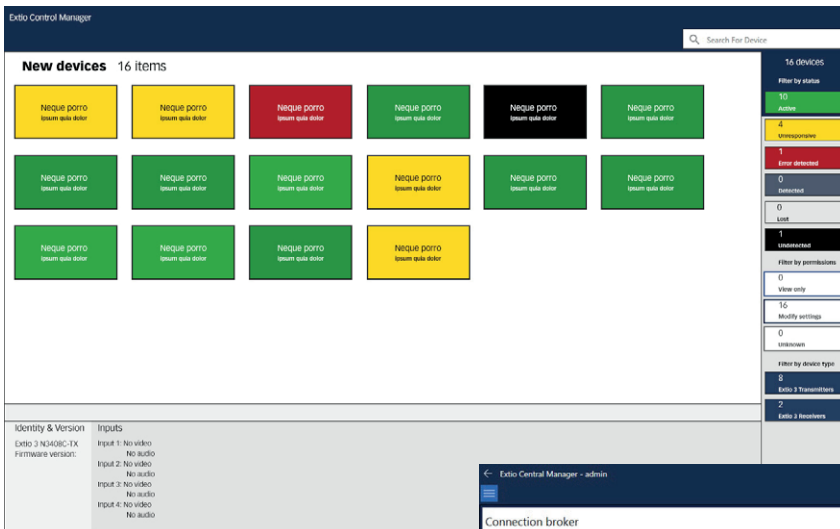

Matrox Extio Central Manager allows administrators to easily discover, configure, and monitor Extio 3 units on the network

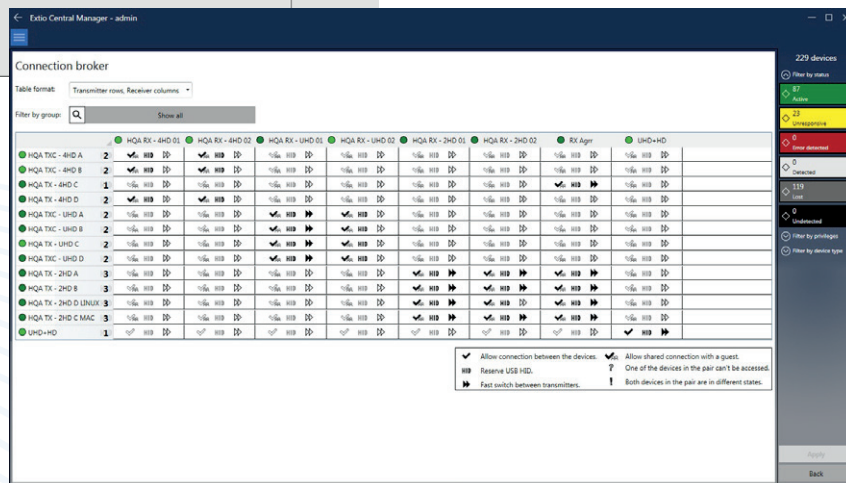

Extio Central Manager provides a matrix view of all Extio 3 units through Connection Broker - create and manage connections between Extio 3 transmitter and receiver units

Distributed model

Extio 3 supports a distributed model of operation—once all the units are configured with Extio Central Manager, the settings and parameters reside in each transmitter and receiver unit. If the central system running the ECM software gets disconnected from the KVM network for some reason, all the Extio 3 units will continue to operate. Unlike other IP KVM solutions, the control system does not become a single point of failure, and does not stop the entire KVM network from working.

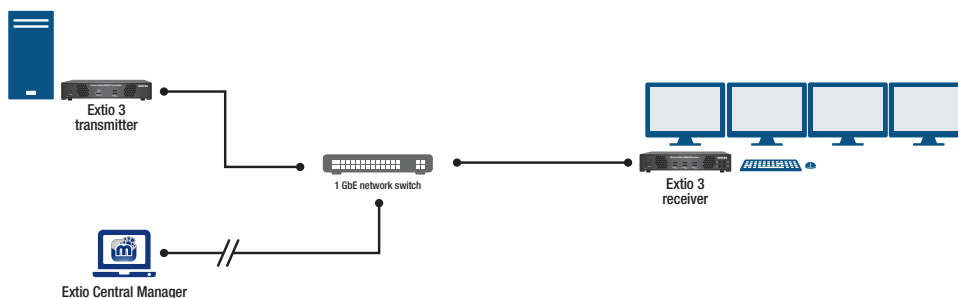

Extio Central Manager's distributed model of operation eliminates single point of failure

Efficient multi-system control

Work more efficiently and increase productivity with Extio 3's Aggregator Mode that allows users to view and operate multiple source computer systems from any Extio receiver unit located at a remote multi-display station, and control them with a single keyboard and mouse set. Aggregator Mode streamlines operations, improving ergonomics, and decluttering of the workspace. The Tile View feature offers an even more efficient way to control multiple systems from a single remote workspace, by displaying up to four separate systems on a single 4K monitor. Control can be shifted from one computer to another seamlessly by moving the mouse freely across multiple desktops. At the instant the mouse cursor moves from the current desktop to the next, the control is smoothly and automatically transferred to the target source system. Programmable hotkeys can also be used for switching between multiple predefined layouts.

The built-in Aggregator Mode supports both independent and stretched desktop configurations. It does not require any software to be installed on the source computer system, and no additional hardware is required for enabling unified multi-system control, avoiding another point of failure and simplifying the KVM installation.

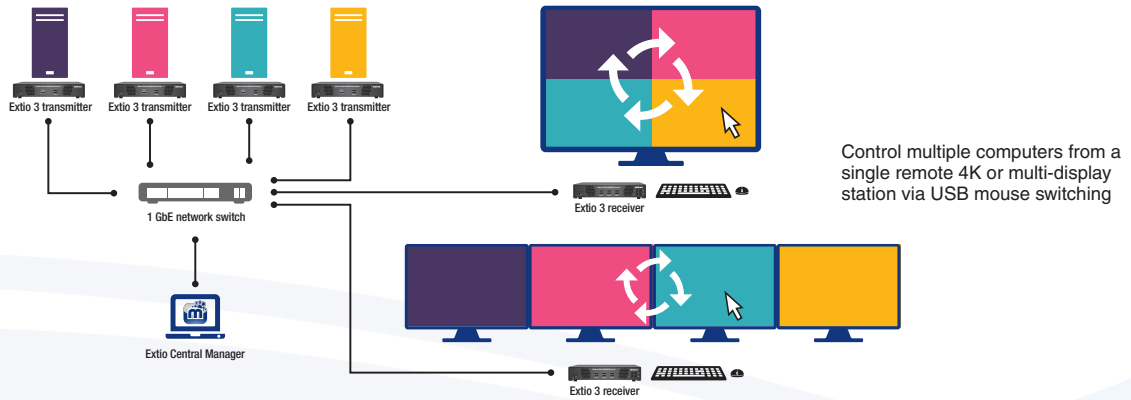

Extio 3 over Internet

Extio 3 over Internet delivers an optimal remote KVM experience by enabling power users, knowledge workers, and broadcast operators and directors to remotely control, share, and manage powerful workstations or specialized equipment as they would on-premises. Integrating advanced security features such as IPSec VPN, multi-factor authentication, and AES 128-bit hardware encryption, Extio 3 ensures secure and safe transmission and communication of high-quality video, audio, and USB signals over LAN, WAN, and internet.



Matrox Extio 3 provides secure, seamless KVM extension over internet for remote workforces

Markets and applications

Matrox KVM extenders are a perfect fit for many industries. Have a specific idea in mind? Contact our sales team and work together to build a solution.



Process Control and Industrial Automation



Healthcare



Military & Defense



Emergency Operation & Dispatch Centers



Broadcast & Post-Production



Transportation



Government



Education

Appliances and cards

Matrox Extio 3 N3408 transmitter appliance (front/back view)

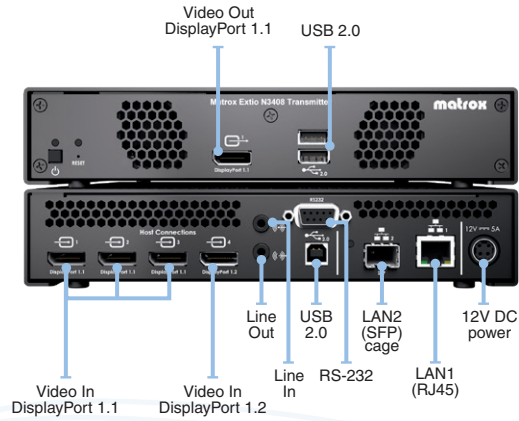

Matrox Extio 3 N3208 transmitter appliance (front/back view)

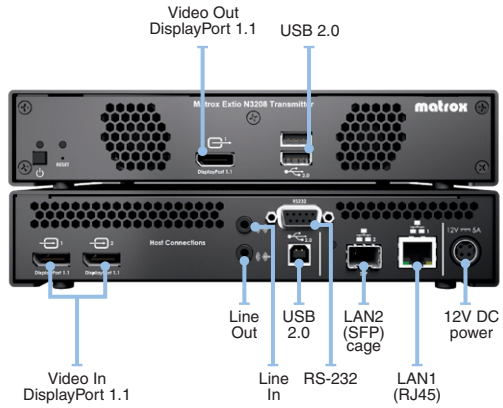

Matrox Extio 3 N3408 receiver appliance (front/back view)

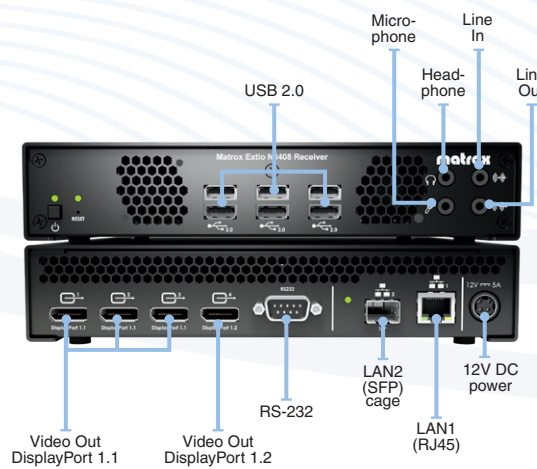

Matrox Extio 3 N3208 receiver appliance (front/back view)

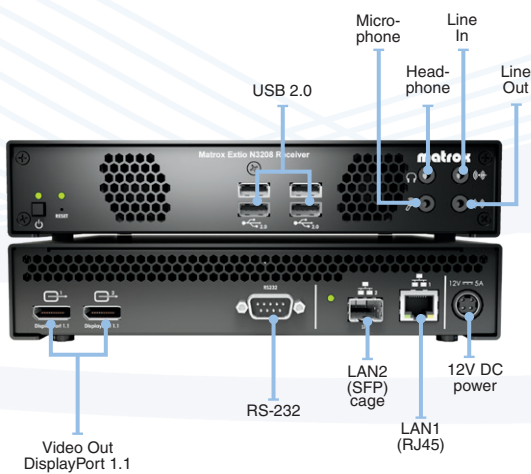

Matrox Extio 3 N3408 transmitter card

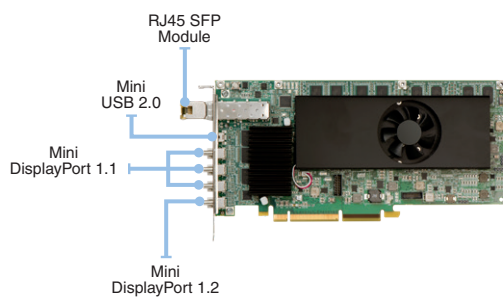

Matrox Extio 3 N3208 transmitter card

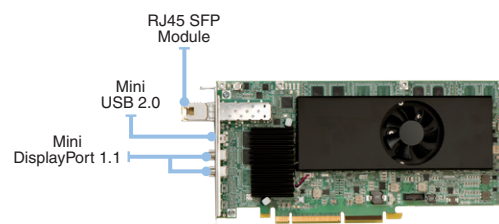

Technical specifications

Extio 3 – N3408

Transmitter appliance

Connections

- 1x DisplayPort 1.2 video input connector
- 3x DisplayPort 1.1 video input connectors
- 1x USB 2.0 Type B
- Line in 3.5 mm, line out 3.5 mm, RS-232 9-pin D-type (supported in certain configurations)

Local Outputs¹

- 1x DisplayPort 1.1
- 2x USB 2.0 Type A

Link

- 1x RJ45 network port
- 1x SFP cage (supports SFP multi-mode or single-mode transceiver, sold separately)

General

- Embedded digital audio through DisplayPort, with option to de-embed digital audio on the receiver unit
- Lockable power connector, external 12V power supply unit
- Standalone or rack-mountable unit (1U ½ R)
- Status LED indicators
- On/off and recessed reset button

Part number

- XTO3-N3408TX

Transmitter card

Connections

- PCI Express x8 electrical and x16 mechanical
- 1x Mini DisplayPort 1.2 video input connector
- 3x Mini DisplayPort 1.1 video input connectors
- 1x USB 2.0 Type mini-B

Link

- 1x SFP cage with RJ45 copper transceiver (upgradeable to fiber multi-mode or single-mode SFP transceiver, sold separately)

General

- Embedded digital audio through DisplayPort, with option to de-embed digital audio on the receiver unit

Part number

- XTO3-N3408CTX

Receiver appliance

Local devices

- 1x DisplayPort 1.2 video output connectors
- 3x DisplayPort 1.1 video output connectors
- 6x USB 2.0 Type A
- Line in 3.5 mm, line out 3.5 mm, mic in 3.5 mm, headphone out 3.5 mm, RS-232 9 Pin D-Type

Link

- 1x RJ45 network port
- 1x SFP cage (supports SFP multimode and single-mode transceivers, sold separately)

General

- Option to de-embed digital audio and convert to analog audio
- Lockable power connector, external 12V power supply unit
- Standalone or rack-mountable unit (1U ½ R)
- Status LED indicators
- On/off and recessed reset button

Part number

- XTO3-N3408RX

Maximum resolution²

- 1x 3840x2160 @60Hz
- 2x 3840x2160 @30Hz
- 2x 2560x1600 @60Hz
- 3x 1920x1200 @60Hz
- 4x 1920x1080 @60Hz
- 4x 1920x1200 @50Hz

1. Not yet enabled. 2. Other resolutions are also supported.

3. Network conditions vary per region. For optimal user experience, we recommend a ping time of less than 20ms and +/- 10% WC jitter. Please contact Matrox for additional details.

Extio 3 – N3208

Transmitter appliance

Connections

- 2x DisplayPort 1.1 video input connectors
- 1x USB 2.0 Type B
- Line in 3.5 mm, line out 3.5 mm, RS-232 9-pin D-type (supported in certain configurations)

Local Outputs¹

- 1x DisplayPort 1.1
- 2x USB 2.0 Type A

Link

- 1x RJ45 network port
- 1x SFP cage (supports SFP multi-mode or single-mode transceiver, sold separately)

General

- Embedded digital audio through DisplayPort, with option to de-embed digital audio on the receiver unit
- Lockable power connector, external 12V power supply unit
- Standalone or rack-mountable unit (1U ½ R)
- Status LED indicators
- On/off and recessed reset button

Part number

- XTO3-N3208TX

Transmitter card

Connections

- PCI Express x8 electrical and x16 mechanical
- 2 x Mini DisplayPort 1.1 video input connectors
- 1x USB 2.0 Type mini-B

Link

- 1x SFP cage with RJ45 copper transceiver (upgradeable to fiber multi-mode or single-mode SFP transceiver, sold separately)

General

- Embedded digital audio through DisplayPort, with option to de-embed digital audio on the receiver unit

Part number

- XTO3-N3208CTX

Receiver appliance

Local devices

- 2x DisplayPort 1.1 video output connectors
- 4x USB 2.0 Type A
- Line in 3.5 mm, line out 3.5 mm, mic in 3.5 mm, headphone out 3.5 mm, RS-232 9 Pin D-Type

Link

- 1x RJ45 network port
- 1x SFP cage (supports SFP multi-mode or single-mode transceiver, sold separately)

General

- Option to de-embed digital audio and convert to analog audio
- Lockable power connector, external 12V power supply unit
- Standalone or rack-mountable unit (1U ½ R)
- Status LED indicators
- On/off and recessed reset button

Part number

- XTO3-N3208RX

Maximum resolution²

- 1x 2560x1600 @60Hz
- 2x 1920x1200 @60Hz

Extio 3 N3408 & N3208

Distance in point-to-point

- OM2, OM3, OM4 (50/125µm) multi-mode - 550 m (1804 ft.)
- OM1 (62.5/125µm) multi-mode cable type - 275 m (902 ft.)
- OS1, OS2 (9/125µm) single-mode cable type - 10 km (6.20 mi)
- Cat5e, Cat6 - 100 m (328 ft.)

Distance over IP

- LAN
- Private WAN
- Internet³

Accessories (sold separately)

- Multi-Mode Fiber Optic Transceiver (part number: XTO3-SFPMM)
- Single-Mode Fiber Optic Transceiver (part number: XTO3-SFPSM)
- Rack Mount Kit (part number: RMK-19TR-A)
- Mini DisplayPort secure cable solution (part number: SK-SLBN-6)
- Under Desk Mounting Brackets (part number: RMK-UDMKIT-A)

NRG Redundant Power Supply

- Rack tray with one NRG RPSU pre-installed (part number: NRG-5-1DB)
- Rack tray with two NRG RPSU pre-installed (part number: NRG-5-2DB)

Contact Matrox

Montreal Headquarters: 1-800-361-4903 (North America), 514-822-6364 (Worldwide) | video@matrox.com

London Office: +44 (1895) 827300

Serving: United Kingdom, Ireland, Benelux, France, Spain, Portugal, Middle East, Africa

Munich Office: +49 89 62170-444

Serving: Germany, Austria, Switzerland, Denmark, Finland, Norway, Sweden, Central and Eastern Europe, the Baltic States, Greece, Turkey, Italy

© 2021 Matrox Graphics, Inc. All rights reserved. Matrox reserves the right to change specifications without notice. Contact Matrox for more details on specific requirements. Matrox and Matrox product names are registered trademarks in Canada or other countries and/or trademarks of Matrox Electronic Systems, Ltd and/or Matrox Graphics Inc. All other company and product names are registered trademarks and/or trademarks of their respective owners. 07/2021

